SecuRope lifeline in an overhead configuration

Description

The SecuRope NEO is a lifeline that can be used in overhead configuration. This configuration is recommended for industrial buildings where the fall clearance is limited.



Compliant with EN795:2012
Type C and CEN/TS16415:2013
MADE IN EU



x 4

Advantages

- Intuitive use
- Comfortable and smooth moving of the glider
- Can be used with retractable fall arresters
- Reduced cable deflection (max 70cm)
- Non deformable components
- Robust and lasting stainless steel material

Technical specifications

Delivered with an installer and user manual

Material: Stainless Steel SS316 & SS304

Maximum span 12m between the anchors

Loading on the anchors max 12KN

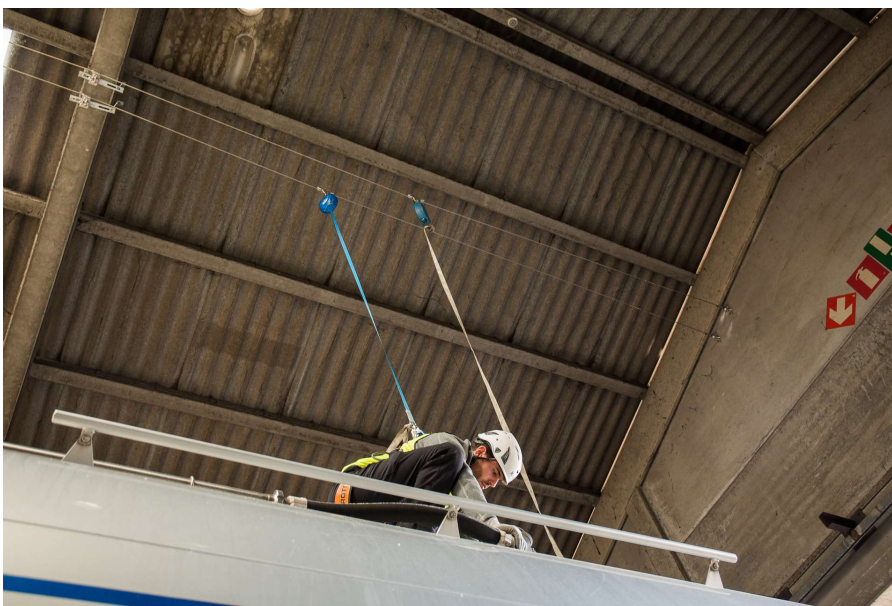

Securope
overhead for
loading trucks

SecuRope lifeline in an overhead configuration

December 2019

Main components of Securope overhead

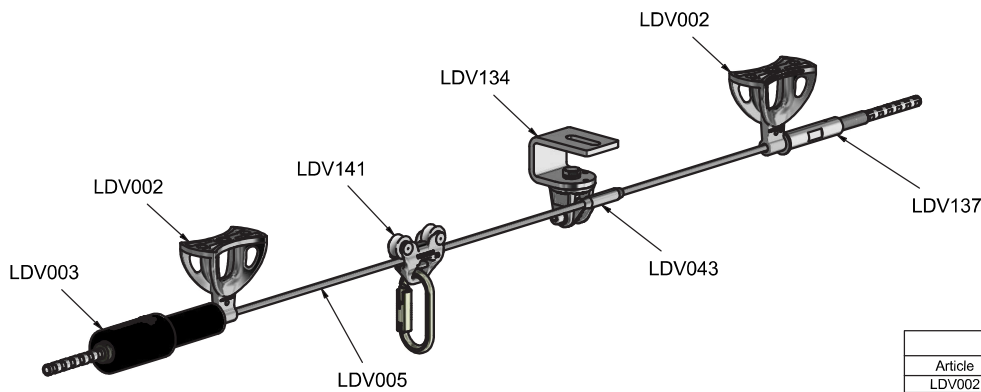

Overhead Life Line	
Article	Description
LDV002	End Anchor 2012
LDV003	Energy absorber assembly
LDV005	Cable 8 mm stainless steel 1x19
LDV043	NEO Intermediate Anchor
LDV133	Glider with Roller
LDV137	Line tensioner

End anchors between walls

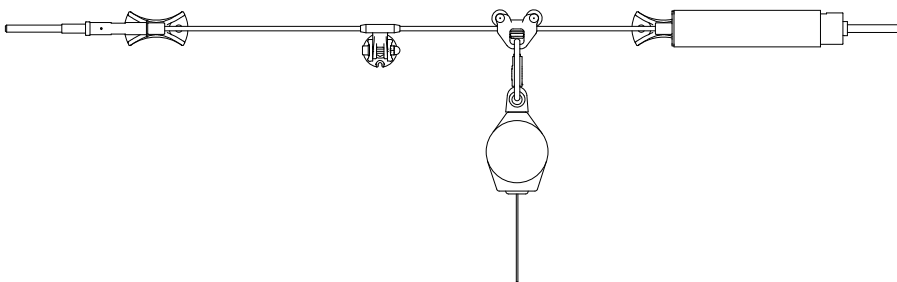

Intermediate bracket on wall

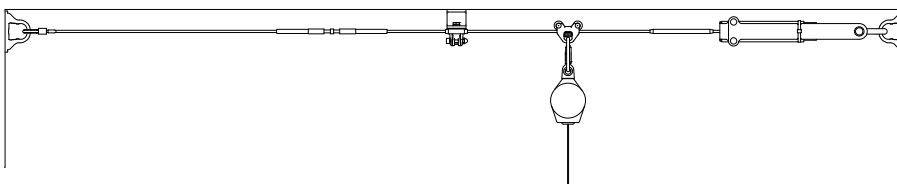

Intermediate bracket on ceiling

SecuRope lifeline in an overhead configuration



FALLPROTEC

December 2019

LDV054

End anchor, wall fixing fitted with a crimping ring and a turnbuckle.

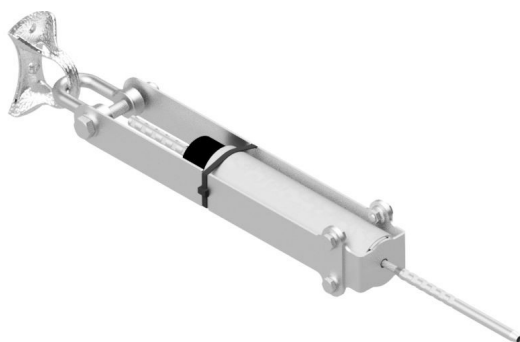

LDV139

End anchor for fixing on wall including energy absorber and crimping ring

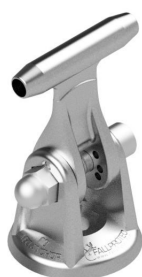

LDV043

The NEO anchor has an orientable cable guide. It can be installed on wall and ceiling.

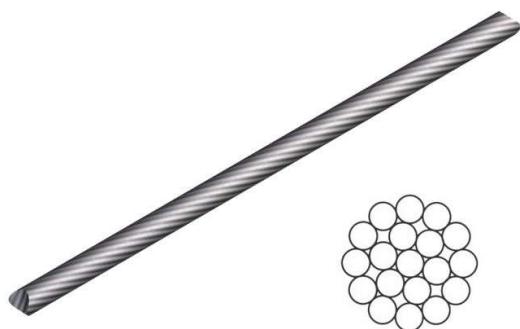

LDV005

Cable Ø 8 mm construction 1x19 SS316

SecuRope lifeline in an overhead configuration

FALLPROTEC

December 2019

Gliders

Two models of gliders are available:

- **LDV060** when the height between the cable and the user is less than 2,5m
- **LDV141** if the height between the cable and the user is greater than 2,5m and a retractable fall arrester is suspended to the glider



LDV060

Captive glider with carabiner



LDV141

Glider for overhead configurations with retractable
